

913-456

Lv7 2021-r4

Modelo-model:

CRUZ Evo Rack Pro P28-140

Lote-Lot-Lot-Lot:

04-21

Peso-Weight-Poids-Gewicht:

38,5 kg / 84,88 lbs

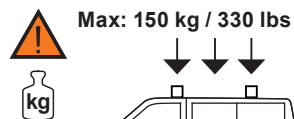
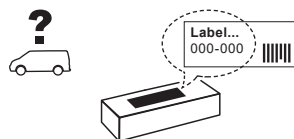

CEE - EEC type approval:

E9 26 R- 04 3024



CRUZBER SAU
ES-A14018311
P.I. Las Salinas II
14960 - Rute - Spain
cruz-products.com

ES	Instrucción de montaje ¡Leer primero!	Portaequipajes
EN	Assembly instructions Read first!	Roof racks
FR	Instruction de montage Lire en premier!	Galeries
DE	Montageanleitung Zuerst lesen!	Dachgepäckträger
PT	Instruções de montagem Ler primeiro!	Porta bagagens
IT	Istruzioni di montaggio Leggere per primo!	Portabagagli
NL	Montagehandleiding Eerst lezen!	Imperiaal
PL	Instrukcja montażu Najpierw przeczytaj!	Bagażnik dachowy
CZ	Montážní návod Čtěte pozorně!	Strešní nosiče
HU	Szerelési Utasítás Először olvasd el!	Csomagtartó
HR	Detaljne upute Prvo procitati!	Portbagaj
RO	Instructiuni de montaj Intai cititi!	Krovni nosač
RU	Инструкции по монтажу Сначала прочитайте!	Багажники на крышу
GR	Διαβάστε προσεκτικά τις Οδηγίες Συναρμολόγησης!	Μπάρες Οροφής
TR	Öncelikle montaj: Talimatlarını okuyunuz!	Taşıyıcı sistem
SI	Navodila za sestavljanje Preberite!	Strešne košare







No compatible con portón trasero
Pas compatible avec hayon
Not suitable for vans with tailgate
Nicht verwendbar bei Fahrzeugen mit Heckklappe.

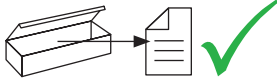

1.

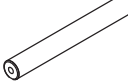
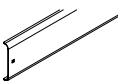
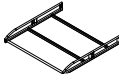

ES	Contenido embalaje: ¡Verificar!	x1		x1
EN	Package content: Check!			
FR	Contenu d'emballage: Vérifier!			
DE	Packungsinhalt: Überprüfen!	x1		x1
PT	Contéudo embalagem: Verificar!			
IT	Contenuto della confezione: Controllare!		(821-154)	(716-373)
NL	Pakket inhoud: Controleer!		140 cm / 55"	140 cm / 55"
PL	Zawartość opakowania: sprawdź!	x1		x1
CZ	Obsah balení: Zkontrolujte!			
HU	Csomag tartalma: Ellenőrizd!		(739-822D)	(739-707T)
HR	Sadržaj paketa: Provjeri!			
RO	Pachetul contine: Verificati!	x6		
RU	Содержание упаковки: Проверьте!			
GR	Ελέγξτε το περιεχόμενο του πακέτου!		1x (805-151)	
			1x (805-153)	
TR	Paket içeriğini: Control ediniz!		1x (805-174)	
			1x (805-332)	
SI	Vsebina paketa: Preverite!		1x (855-218)	
			1x (855-521)	

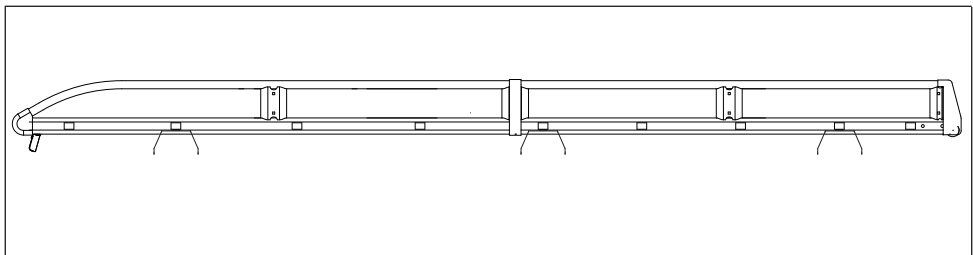

2. 

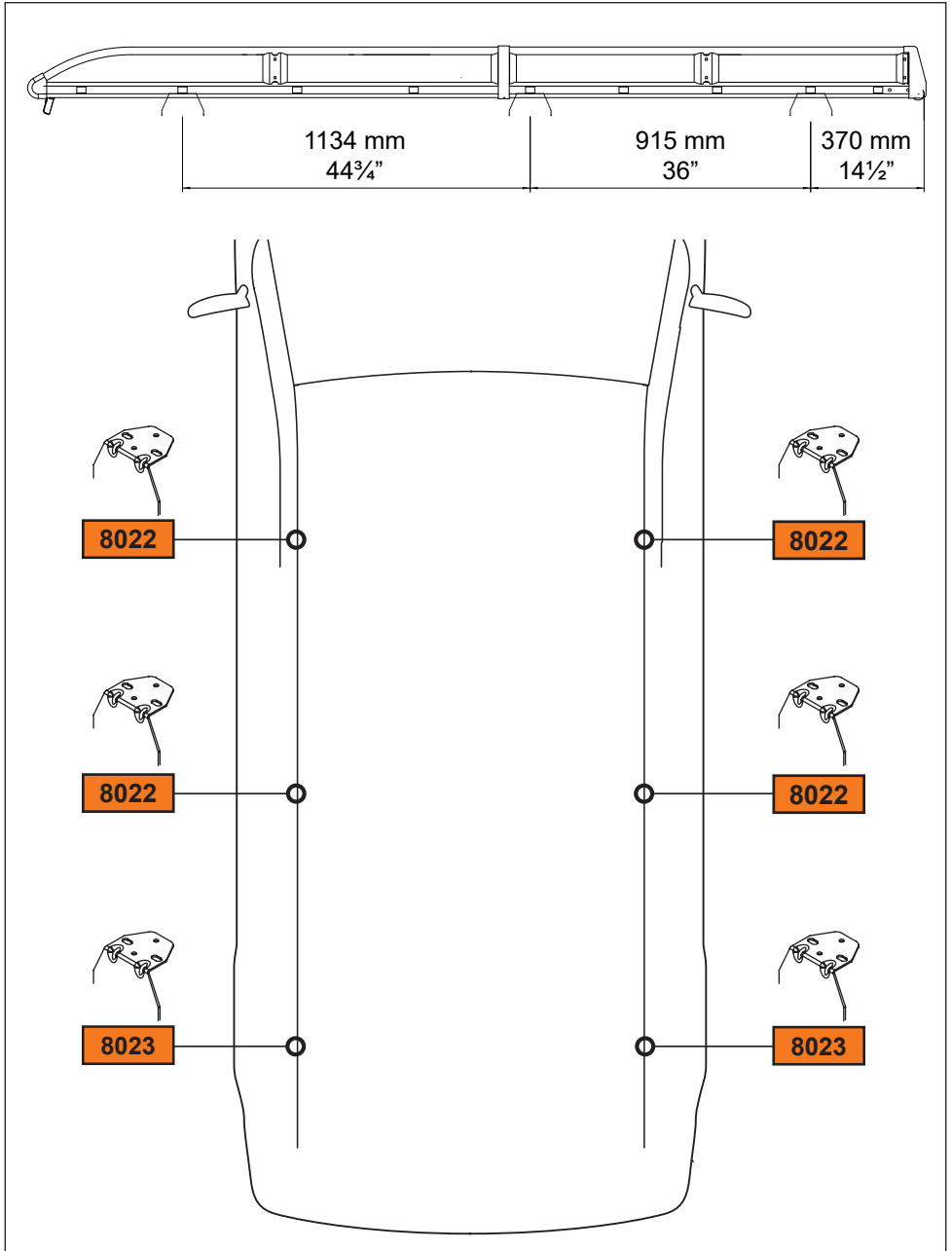

3. 

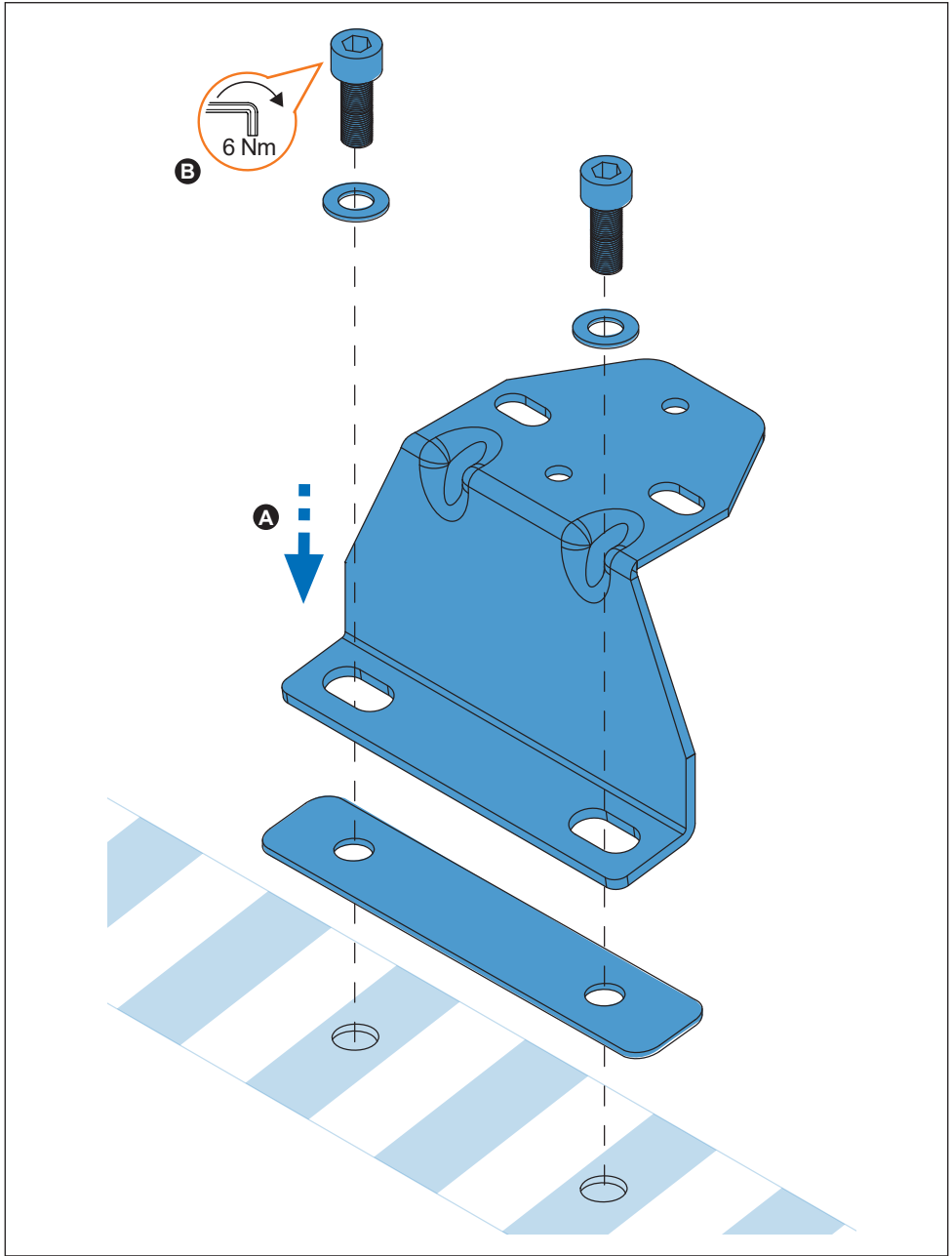

4. 

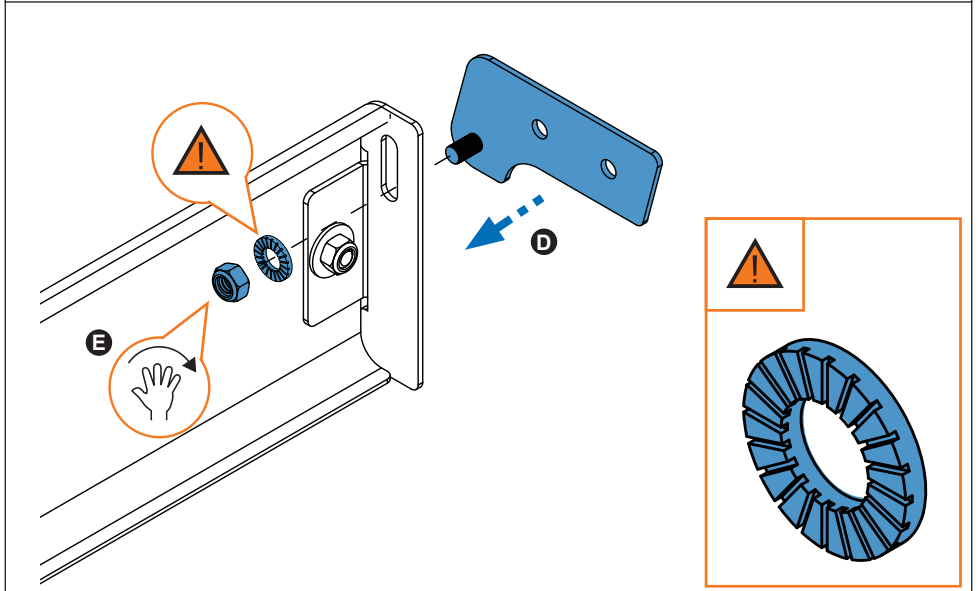
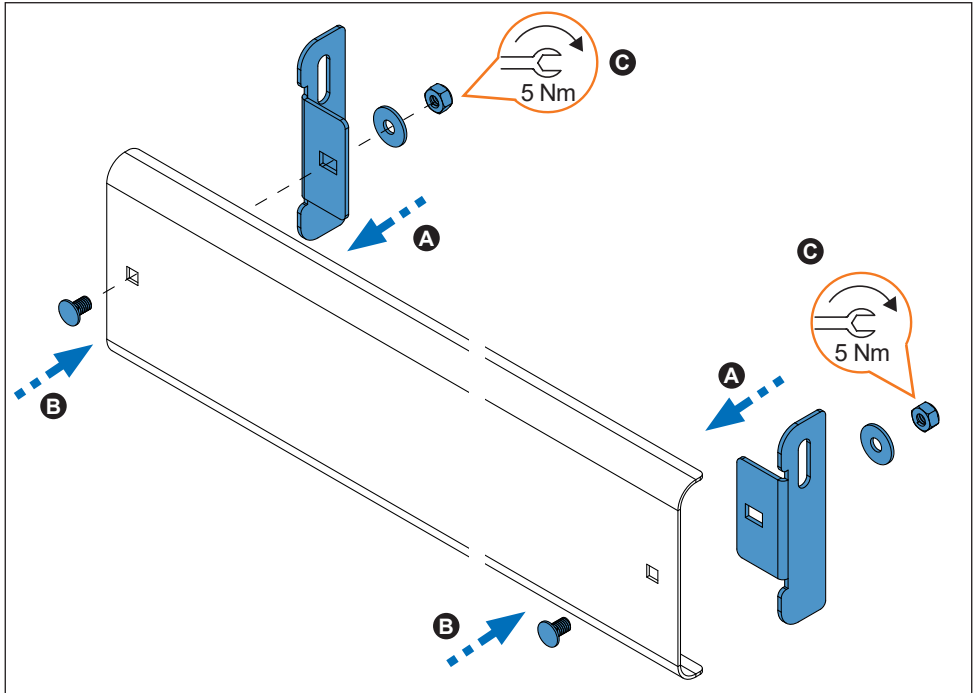
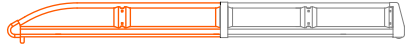

5. 

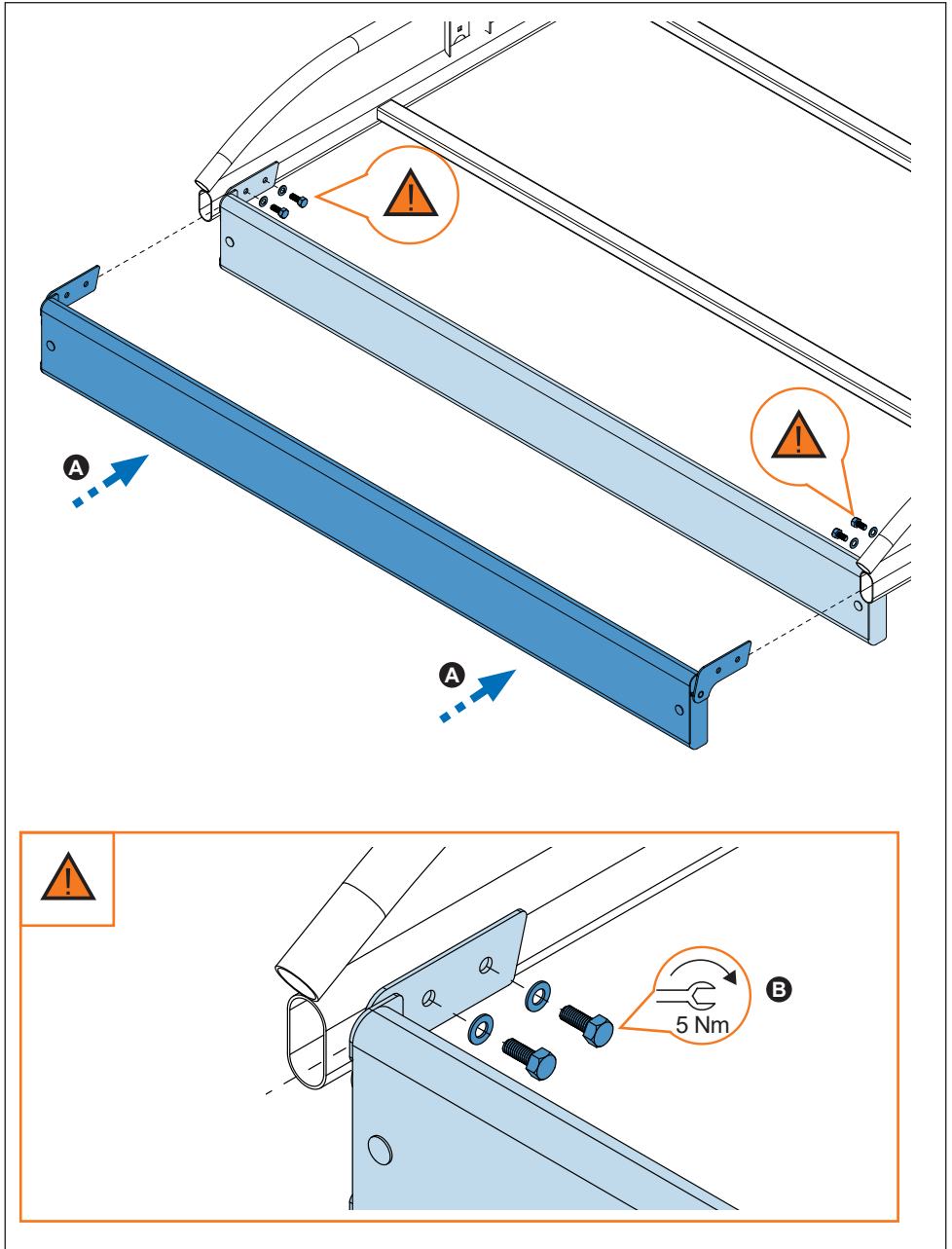
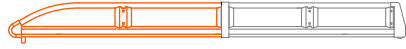

6. 

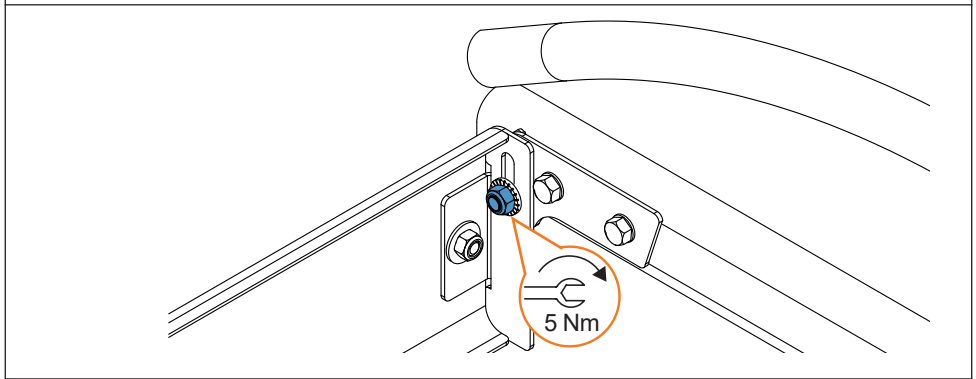
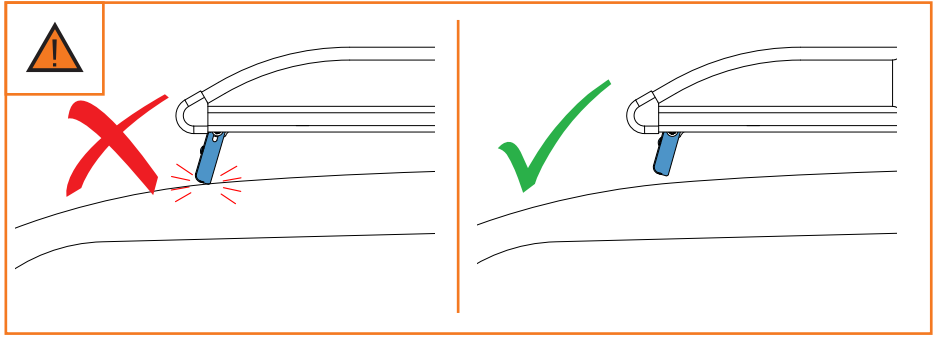
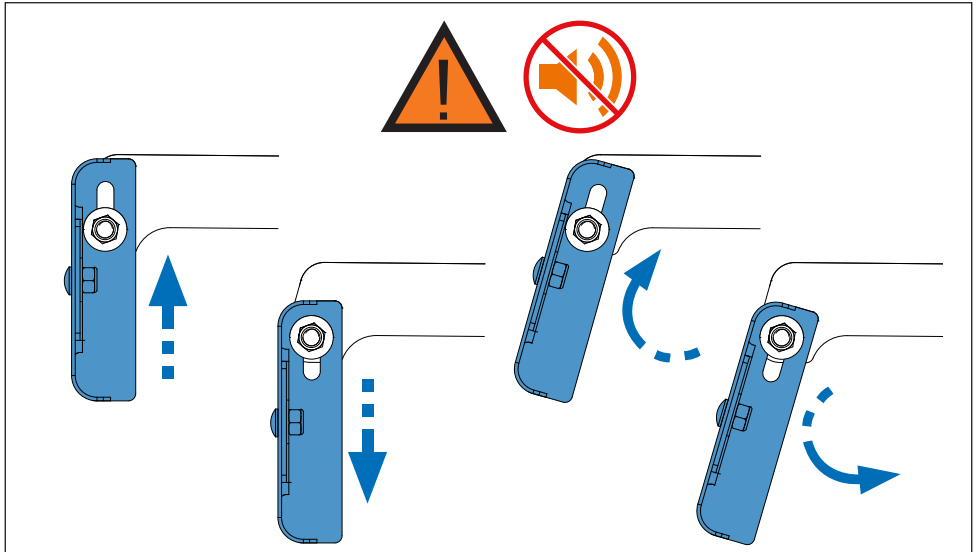
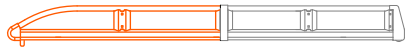

7. 

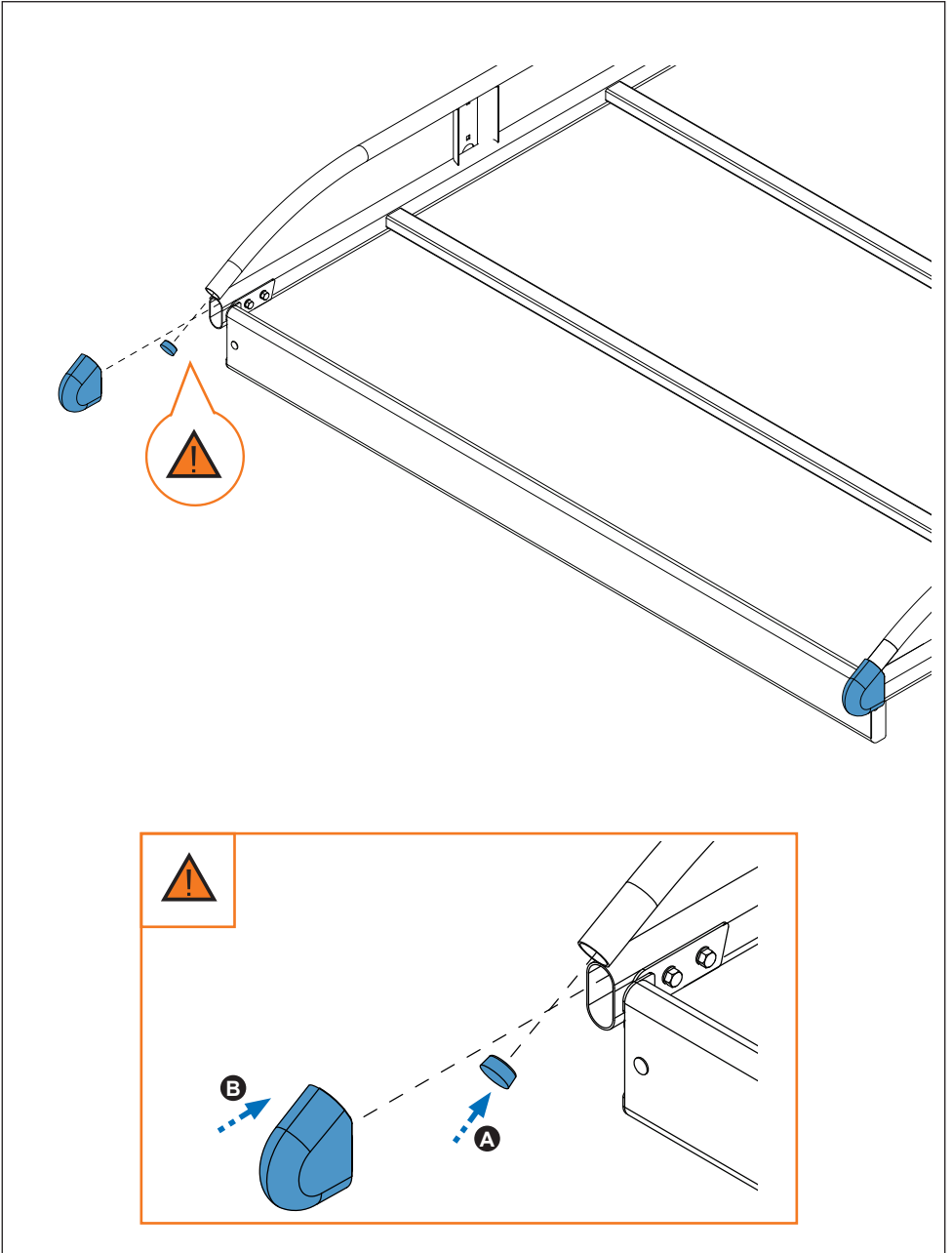
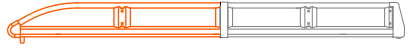

8. 

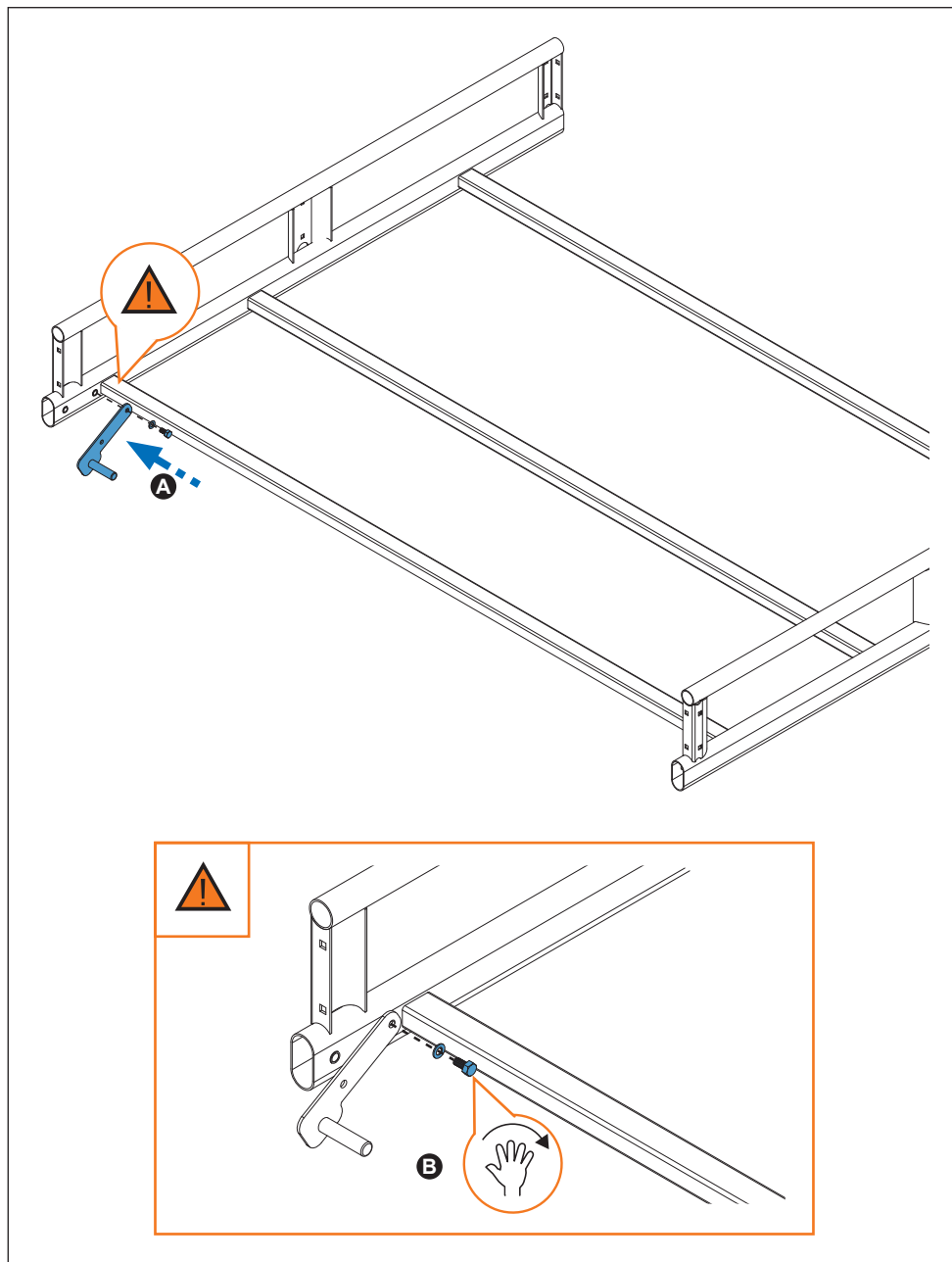
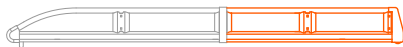

9. 

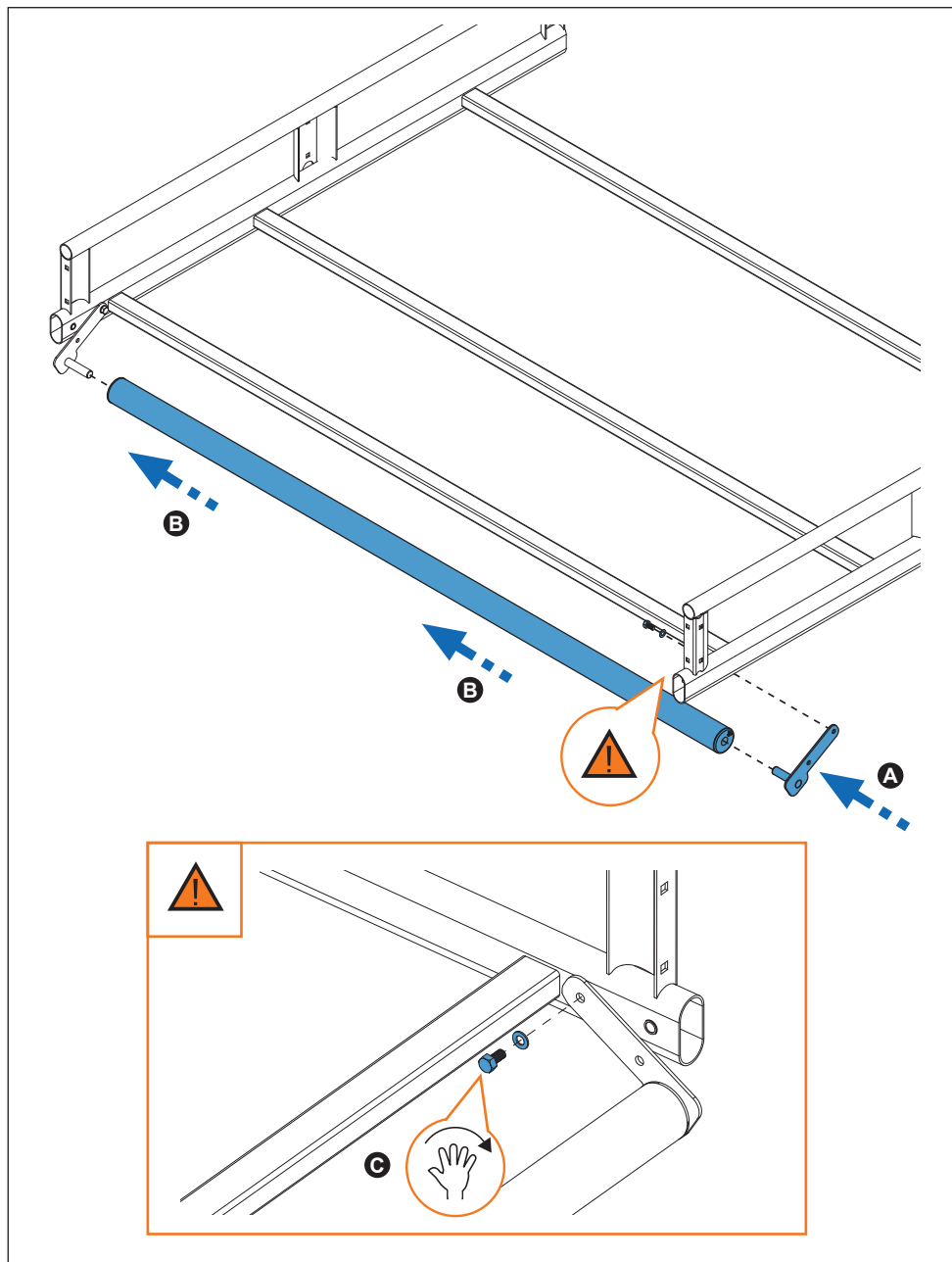
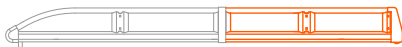

10.

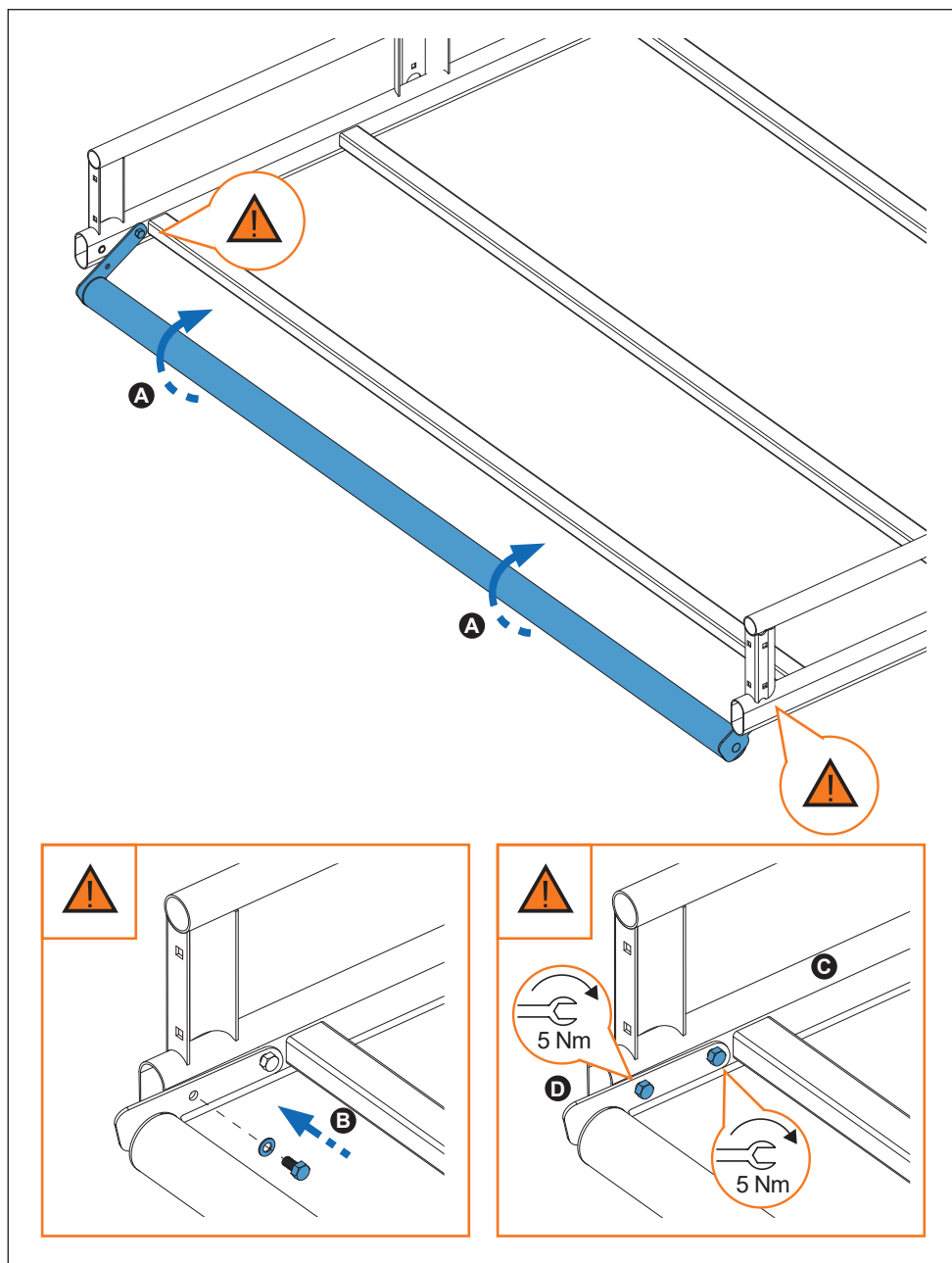
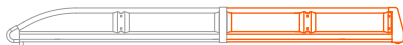

11.

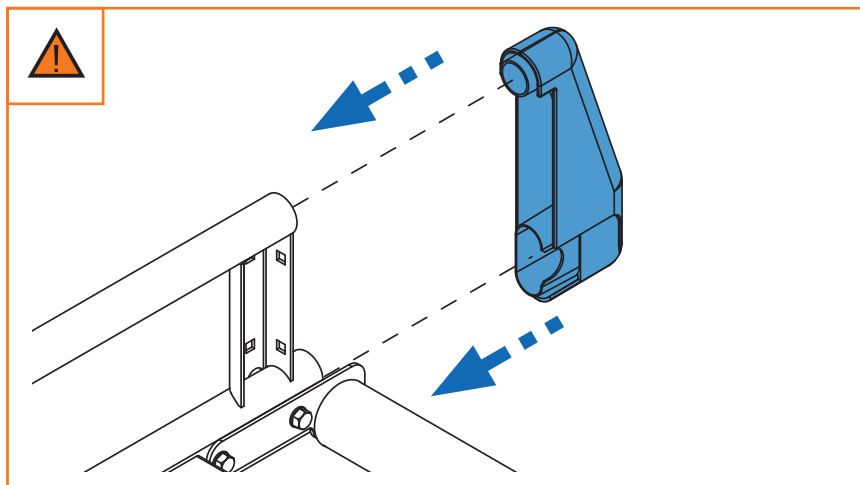
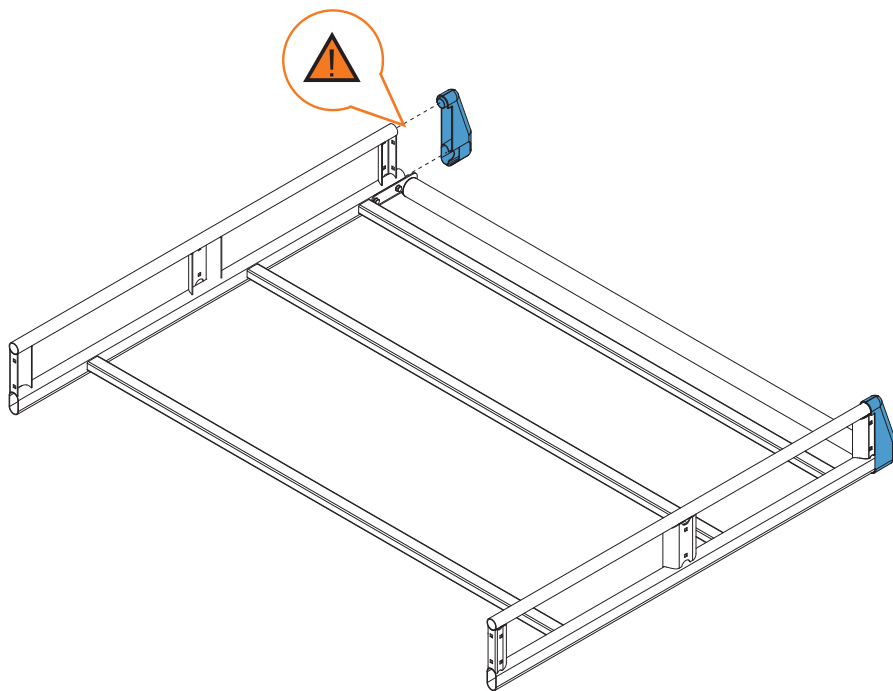
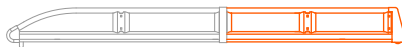

12.

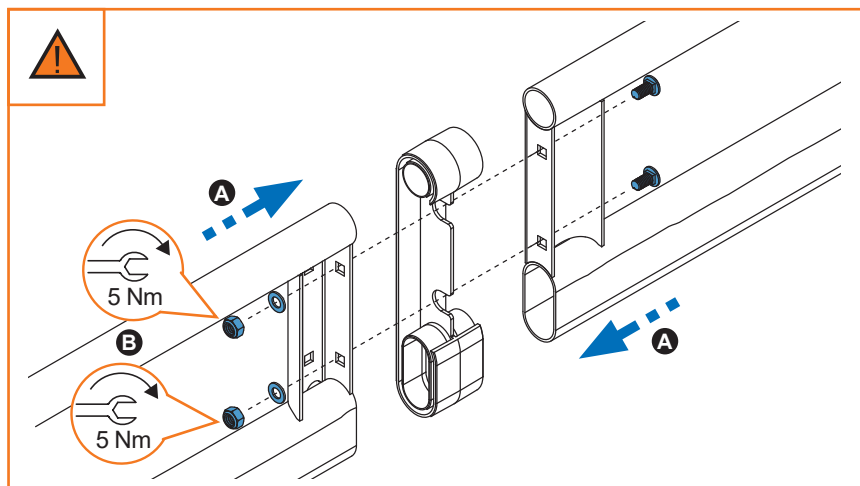
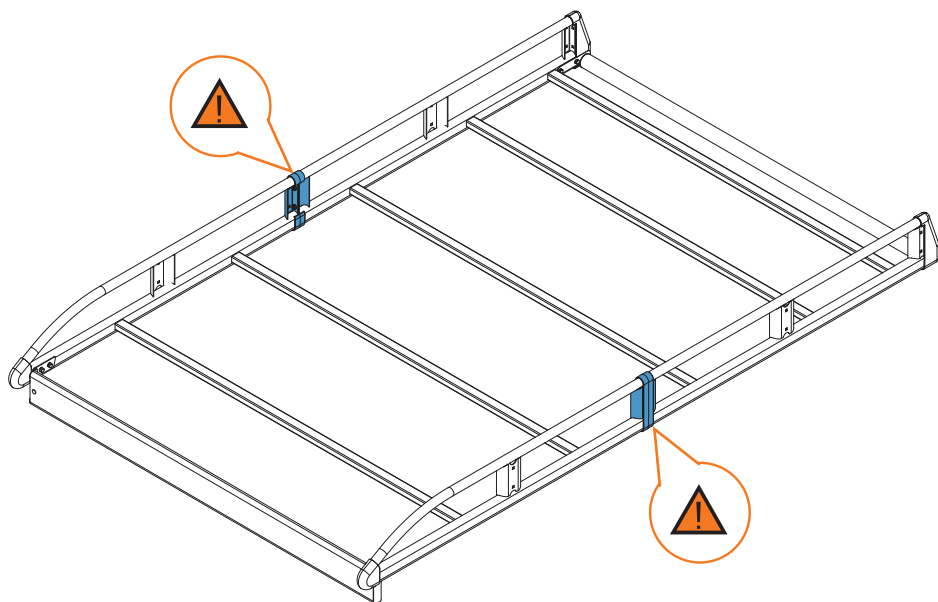
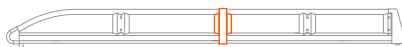

13.

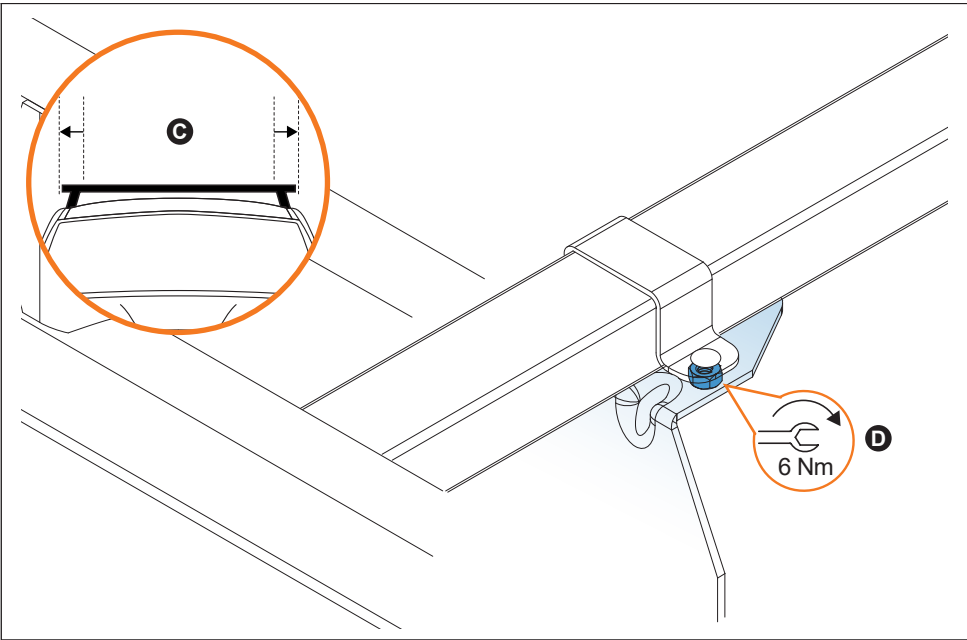
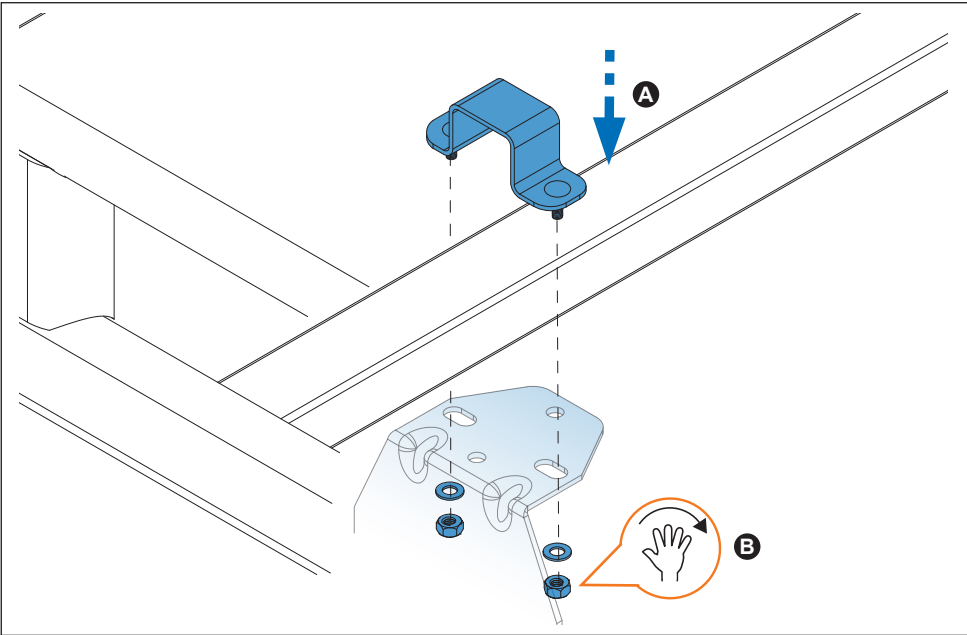
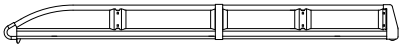

14.

