

925-08x

Lv7 2023-r10

Modelo-model:

CRUZ Alu Cargo AF Dark

Lote-Lot-Lot-Lot:



Peso-Weight-Poids-Gewicht:

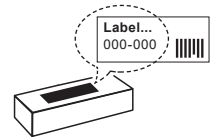

Max. 50 kg / 110 lbs

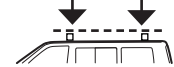

CEE - EEC type approval:



26 R- 04 3022



CRUZBER SAU
ES-A14018311
P.I. Las Salinas II
14960 - Rute - Spain
www.cruz-products.com

| | | |
|----|--|------------------------|
| ES | Instrucción de montaje ¡Leer primero! | Barras de aluminio |
| EN | Assembly instructions Read first! | Aluminium bars |
| FR | Instruction de montage Lire en premier! | Barres d'aluminium |
| DE | Montageanleitung Zuerst lesen! | Aluminiumdachträger |
| PT | Instruções de montagem Ler primeiro! | Barras d'alumínio |
| IT | Istruzioni di montaggio Leggere per primo! | Barre di alluminio |
| NL | Montagehandleiding Eerst lezen! | Aluminium dakdragers |
| PL | Instrukcja montażu Najpierw przeczytaj! | Belki aluminiowe |
| CZ | Montážní návod Čtěte pozorně! | Hliníková sada tyčí |
| HU | Szerelési Utasítás Először olvasd el! | Alumínium rudak |
| HR | Detaljne upute Prvo procitati! | Bare din aluminiu |
| RO | Instructiuni de montaj Intai cititi! | Aluminijske šipke |
| RU | Инструкции по монтажу Сначала прочитайте! | Алюминиевые поперечины |
| GR | Διαβάστε προσεκτικά τις Οδηγίες Συναρμολόγησης! | Μπάρες Αλουμινίου |
| TR | Öncelikle montaj: Talimatlarını okuyunuz! | Alüminyum barlar |
| SI | Navodila za sestavljanje Preberite! | Aluminijske prečke |



1.



ES Contenido embalaje: ¡Verificar!

x1

x1

EN Package content: Check!

FR Contenu d'emballage: Vérifier!

DE Packungsinhalt: Überprüfen!

PT Contéudo embalagem:
Verificar!IT Contenuto della confezione:
Controllare!

NL Pakket inhoud: Controleer!

PL Zawartość opakowania:
sprawdź!

CZ Obsah balení: Zkontrolujte!

HU Csomag tartalma: Ellenőrizd!

HR Sadržaj paketa: Provjeri!

RO Pachetul contine: Verificati!

RU Содержание упаковки:
Проверьте!GR Ελέγξτε το περιεχόμενο: του
πακέτου!





TR Paket içeriğini: Control ediniz!

SI Vsebina paketa: Preverite!

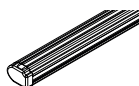

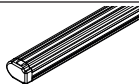
x1



| Código Code |  |  |  |  | Lote Lot |
|----------------|---|---|---|---|-------------|
| 925-100 | AF 118 (824-062) | 118 cm / 46" | 1x (749-066) 1x (749-052) | 1,85 kg / 4,08 lbs | 02/23 |
| 925-085 | AF 128 (824-063) | 128 cm / 50" | 1x (749-067) 1x (749-052) | 2,00 kg / 4,41 lbs | 02/23 |
| 925-086 | AF 138 (824-068) | 138 cm / 54" | 1x (749-069) 1x (749-052) | 2,12 kg / 4,67 lbs | 02/23 |
| 925-087 | AF 148 (824-073) | 148 cm / 58" | 1x (749-070) 1x (749-052) | 2,30 kg / 5,07 lbs | 02/23 |
| 925-088 | AF 158 (824-078) | 158 cm / 62" | 1x (749-071) 1x (749-052) | 2,40 kg / 5,29 lbs | 02/23 |
| 925-089 | AF 175 (824-083) | 175 cm / 69" | 1x (749-073) 1x (749-052) | 2,50 kg / 5,51 lbs | 02/23 |

2.



Importante!
Important!
Important!
Wichtig!

- ES Estas barras tienen que usarse con Kits de fijación CRUZ!
- EN Bars must be used with CRUZ fixation Kits!
- FR Les barres devront être utilisées avec les Kits de fixation CRUZ!
- DE Die Dachträger nur mit CRUZ Stützfuß-Kits befestigen!
- PT As barras devem ser utilizadas com os Kits de fixação CRUZ!
- IT Questa bare deve essere utilizzato solo con il kit di fissaggio CRUZ!
- NL Dakdragers moeten worden gebruikt in combinatie met de bevestigingssets van CRUZ!

- PL Belki muszą być stosowane z elementami mocującymi firmy CRUZ!
- CZ Tento nosič musí být používán s fixačním kitem CRUZ!
- HU A rudakat csak CRUZ rögzítő készlettel szabad használni!
- HR Šipke moraju biti korištene sa CRUZ kitovima za montažu!
- RO Barele trebuie utilizate cu Kit-uri de fixare CRUZ!
- RU Поперечины должны быть использованы со специальным крепежным комплектом CRUZ!
- GR Το αξεσουάρ αυτό θα πρέπει να χρησιμοποιείται αποκλειστικά στα συστήματα μπαρών της CRUZ!
- TR Bu barlar mutlak CRUZ montaj kiti!
- SI Prečke je potrebno uporabiti s CRUZ kiti za pričvrščanje

1

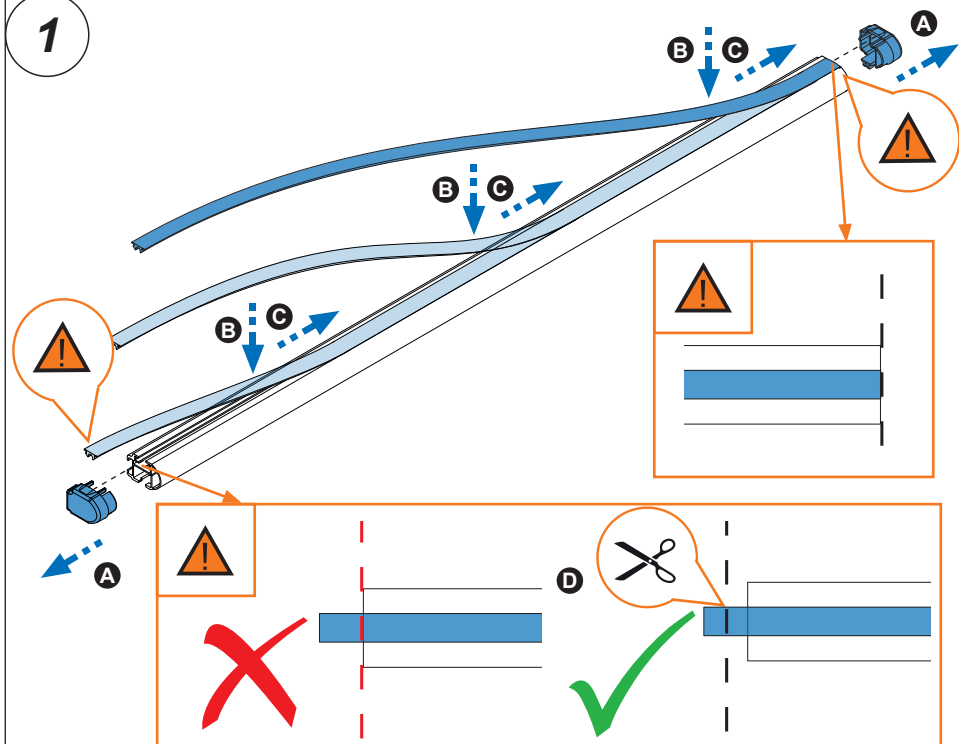

3. 

2

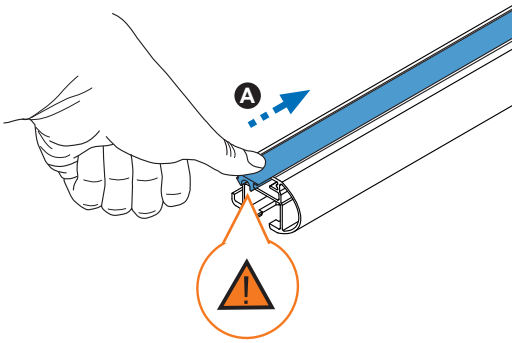





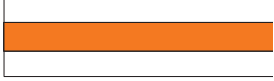



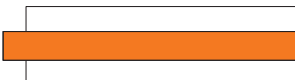

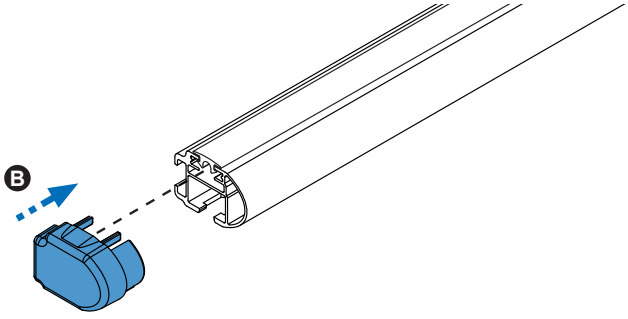



3

  → 