

ES	Instrucción de montaje ¡Leer primero!	Barras de aluminio
EN	Assembly instructions Read first!	Aluminium bars
FR	Instruction de montage Lire en premier!	Barres d'aluminium
DE	Montageanleitung Zuerst lesen!	Aluminiumdachträger
PT	Instruções de montagem Ler primeiro!	Barras d'alumínio
IT	Istruzioni di montaggio Leggere per primo!	Barre di alluminio
NL	Montagehandleiding Eerst lezen!	Aluminium dakdragers
PL	Instrukcja montażu Najpierw przeczytaj!	Belki aluminiowe
CZ	Montážní návod Čtěte pozorně!	Hliníková sada tyčí
HU	Szerelési Utasítás Először olvasd el!	Alumínium rudak
HR	Detaljne upute Prvo procitati!	Bare din aluminiu
RO	Instructiuni de montaj Intai cititi!	Aluminijske šipke
RU	Инструкции по монтажу Сначала прочитайте!	Алюминиевые поперечины
GR	Διαβάστε προσεκτικά τις Οδηγίες Συναρμολόγησης!	Μπάρες Αλουμινίου
TR	Öncelikle montaj: Talimatlarını okuyunuz!	Alüminyum barlar
SI	Navodila za sestavljanje Preberite!	Aluminijske prečke

925-09x

Lv7 2023-r2

Modelo-model:

CRUZ Alu Cargo AF Dark

Lote-Lot-Lot-Lot:



Peso-Weight-Poids-Gewicht:

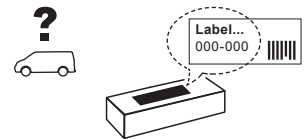

 **Max. 100 kg / 220 lbs**



CEE - EEC type approval:

 26 R- 04 3022



CITY CRASH 

CRUZBER SAU
ES-A14018311
P.I. Las Salinas II
14960 - Rute - Spain
www.cruz-products.com



1.

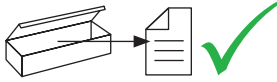

ES Contenido embalaje: ¡Verificar!

x1

x1

EN Package content: Check!



FR Contenu d'emballage: Vérifier!

DE Packungsinhalt: Überprüfen!

x2

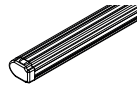
PT Contéudo embalagem:
Verificar!IT Contenuto della confezione:
Controllare!

NL Pakket inhoud: Controleer!

PL Zawartość opakowania:
sprawdź!

CZ Obsah balení: Zkontrolujte!

HU Csomag tartalma: Ellenőrizd!





HR Sadržaj paketa: Provjeri!

RO Pachetul contine: Verificati!

RU Содержание упаковки:
Проверьте!GR Ελέγξτε το περιεχόμενο του
πακέτου!

TR Paket içeriğini: Kontrol ediniz!

SI Vsebina paketa: Preverite!

Código Code					Lote Lot
925-101	AF Dark 118 (824-061)	118 cm / 46"	2x (749-066) 1x (749-053)	3,22 kg / 7,10 lbs	02/23
925-090	AF Dark 128 (824-063)	128 cm / 50"	2x (749-067) 1x (749-053)	3,74 kg / 8,25 lbs	02/23
925-091	AF Dark 138 (824-068)	138 cm / 54"	2x (749-069) 1x (749-053)	3,93 kg / 8,66 lbs	02/23
925-092	AF Dark 148 (824-073)	148 cm / 58"	2x (749-070) 1x (749-053)	4,11 kg / 9,06 lbs	02/23
925-093	AF Dark 158 (824-078)	158 cm / 62"	2x (749-071) 1x (749-053)	4,30 kg / 9,48 lbs	02/23
925-094	AF Dark 175 (824-083)	175 cm / 89"	2x (749-073) 1x (749-053)	5,00 kg / 11,02 lbs	02/23

2.



Importante!
Important!
Important!
Wichtig!

- ES Estas barras tienen que usarse con Kits de fijación CRUZ!
- EN Bars must be used with CRUZ fixation Kits!
- FR Les barres devront être utilisées avec les Kits de fixation CRUZ!
- DE Die Dachträger nur mit CRUZ Stützfuß-Kits befestigen!
- PT As barras devem ser utilizadas com os Kits de fixação CRUZ!
- IT Questa bare deve essere utilizzato solo con il kit di fissaggio CRUZ!
- NL Dakdragers moeten worden gebruikt in combinatie met de bevestigingssets van CRUZ!

- PL Belki muszą być stosowane z elementami mocującymi firmy CRUZ!
- CZ Tento nosič musí být používán s fixačním kitem CRUZ!
- HU A rudakat csak CRUZ rögzítő készlettel szabad használni!
- HR Šipke moraju biti korištene sa CRUZ kitovima za montažu!
- RO Barele trebuie utilizate cu Kit-uri de fixare CRUZ!
- RU Поперечины должны быть использованы со специальным крепежным комплектом CRUZ!
- GR Το αξεσουάρ αυτό θα πρέπει να χρησιμοποιείται αποκλειστικά στα συστήματα μπαρών της CRUZ!
- TR Bu barlar mutlak CRUZ montaj kiti!
- SI Prečke je potrebno uporabiti s CRUZ kiti za pričvrščanje

1

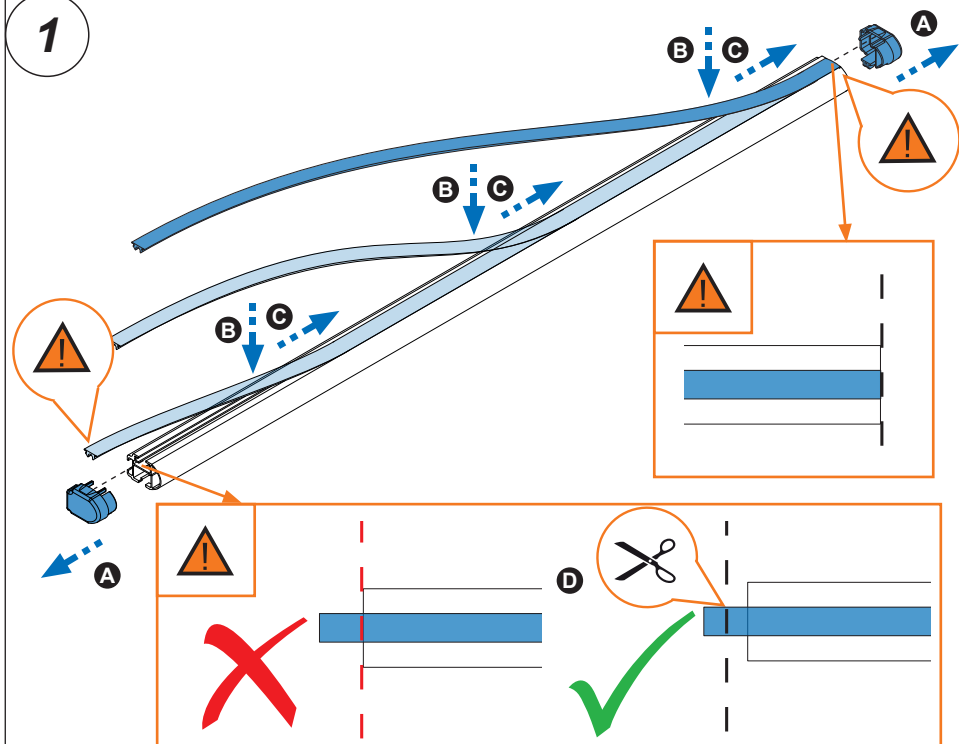

3. 

2

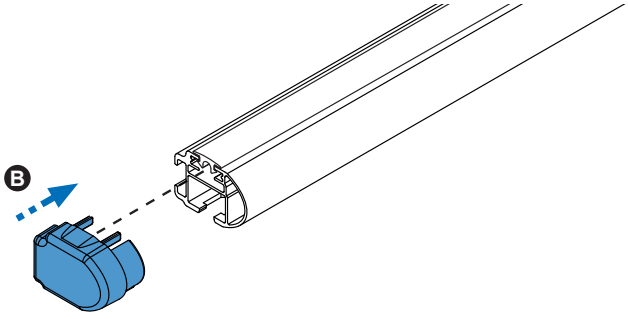
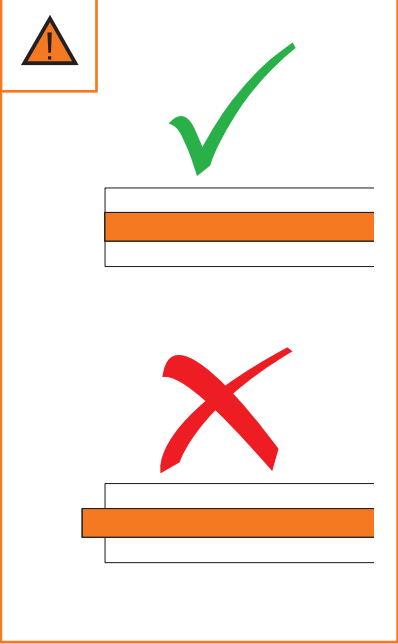
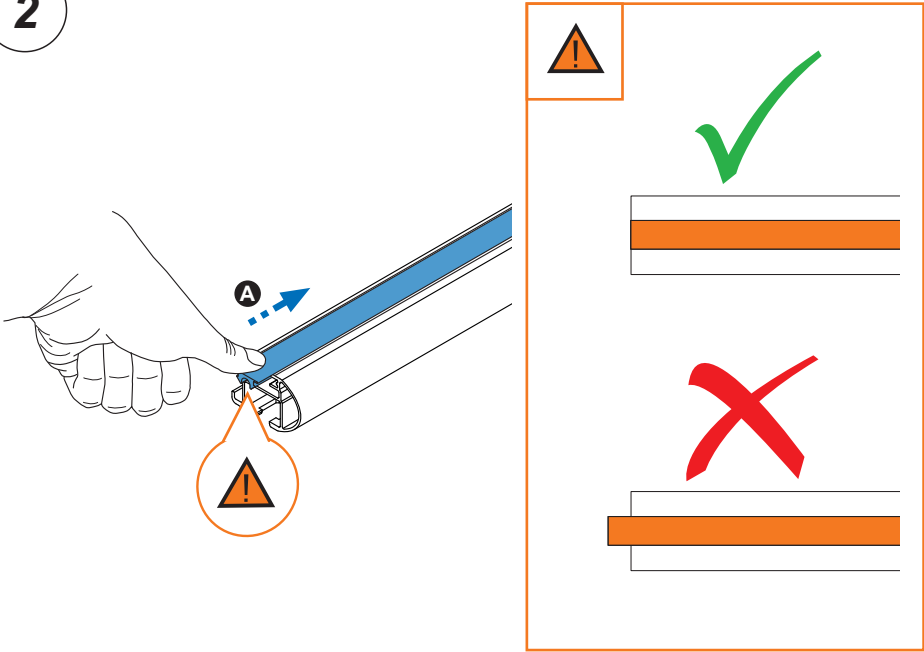

3

