

| | | |
|----|---|-------------------------|
| ES | Instrucción de montaje ¡Leer primero! | Kit fijación |
| EN | Assembly instructions Read first! | Fixation Kit |
| FR | Instruction de montage Lire en premier! | Kit fixation |
| DE | Montageanleitung Zuerst lesen! | Stützfuß-Kit |
| PT | Instruções de montagem Ler primeiro! | Kit fixação |
| IT | Istruzioni di montaggio Leggere per primo! | Kit di fissaggio |
| NL | Montagehandleiding Eerst lezen! | Bevestigingsset |
| PL | Instrukcja montażu Najpierw przeczytaj! | Element mocujący |
| CZ | Montážní návod Čtěte pozorně! | Fixační kit |
| HU | Szerelési Utasítás Először olvasd el! | Rögzítő készlet |
| HR | Detaljne upute Prvo procitati! | Kit za montažu |
| RO | Instructiuni de montaj Intai cititi! | Kit de fixare |
| RU | Инструкции по монтажу Сначала прочитайте! | Крепежный комплект |
| GR | Διαβάστε προσεκτικά τις Οδηγίες Συναρμολόγησης! | Κιβώτιο (Kit) Επίσκευής |
| TR | Öncelikle montaj: Talimatlarını okuyunuz! | Montaj kiti |
| SI | Navodila za sestavljanje Preberite! | Kit za pričvrstitev |

934-447

Lv7 2022-r1

Modelo-model:

Kit 6 soportes CRUZ LCV

Lote-Lot-Lot-Lot:

01-21

Peso-Weight-Poids-Gewicht:

3,10 kg / 6,75 lbs

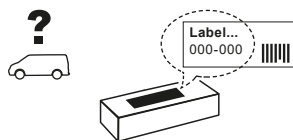

Max: 150 kg / 330 lbs

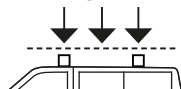

CEE - EEC type approval:



26 R- 04 3022



CITY CRASH (↻)

CRUZBER SAU
ES-A14018311
P.I. Las Salinas II
14960 - Rute - Spain
www.cruz-products.com



1.

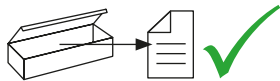

ES Contenido embalaje: ¡Verificar!

x1



x6

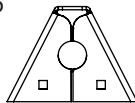

(500)

EN Package content: Check!

FR Contenu d'emballage: Vérifier!

DE Packungsinhalt: Überprüfen!

PT Contéudo embalagem:
Verificar!

x6

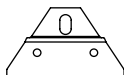

x6

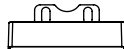

IT Contenuto della confezione:
Controllare!

NL Pakket inhoud: Controleer!

4x (859)

2x (012-231)

PL Zawartość opakowania:
sprawdź!

2x (858)

4x (012-232)

CZ Obsah balení: Zkontrolujte!

HU Csomag tartalma: Ellenőrizd!

x6

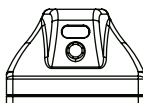

x3



HR Sadržaj paketa: Provjeri!

RO Pachetul contine: Verificati!

(813-073)

1x (805-025)

RU Содержание упаковки:
Проверьте!

1x (810-094)

GR Ελέγξτε το περιεχόμενο του
πακέτου!

1x (810-181)

TR Paket içeriğini: Kontrol ediniz!

SI Vsebina paketa: Preverite!

2.

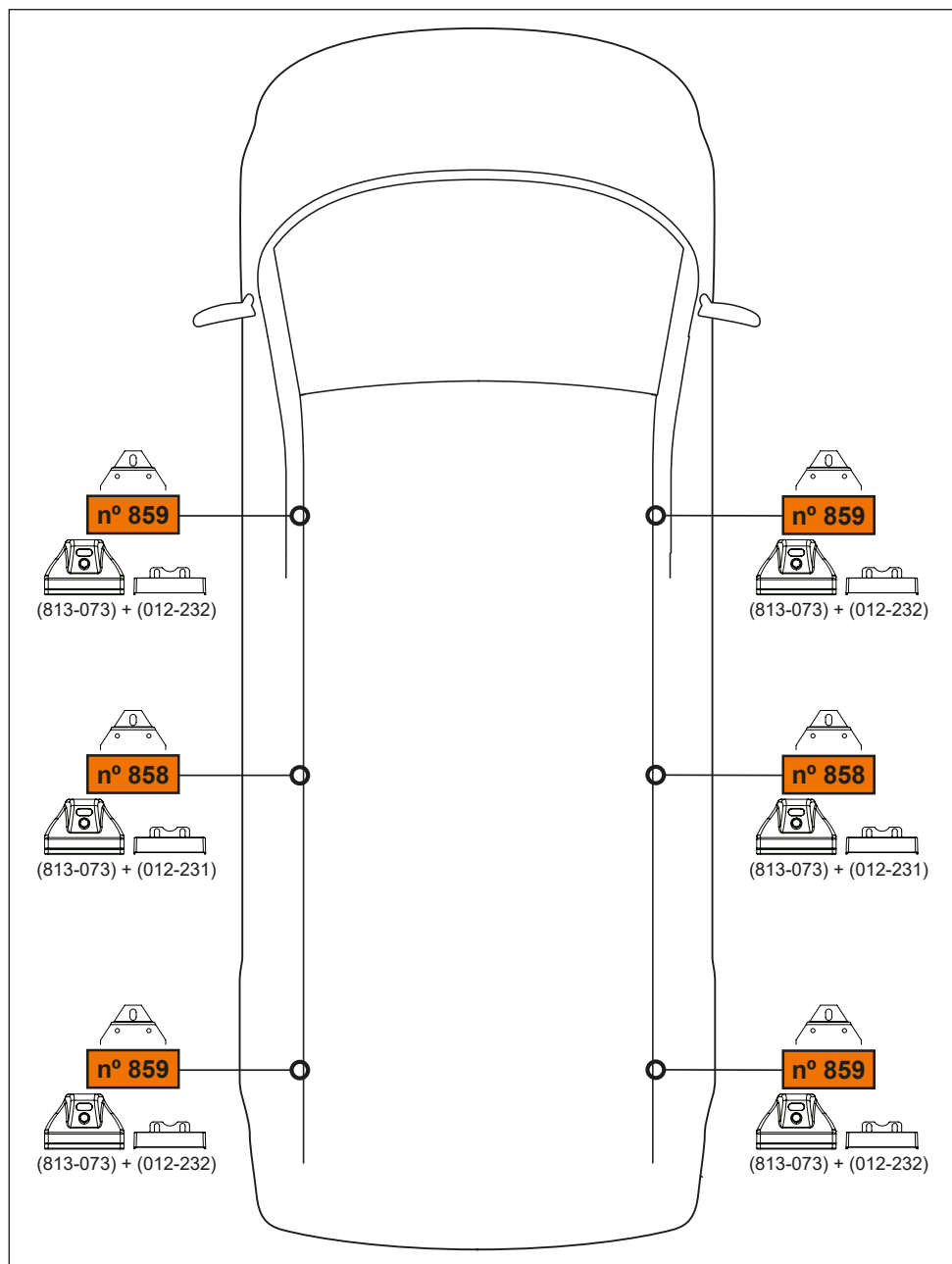

3. 

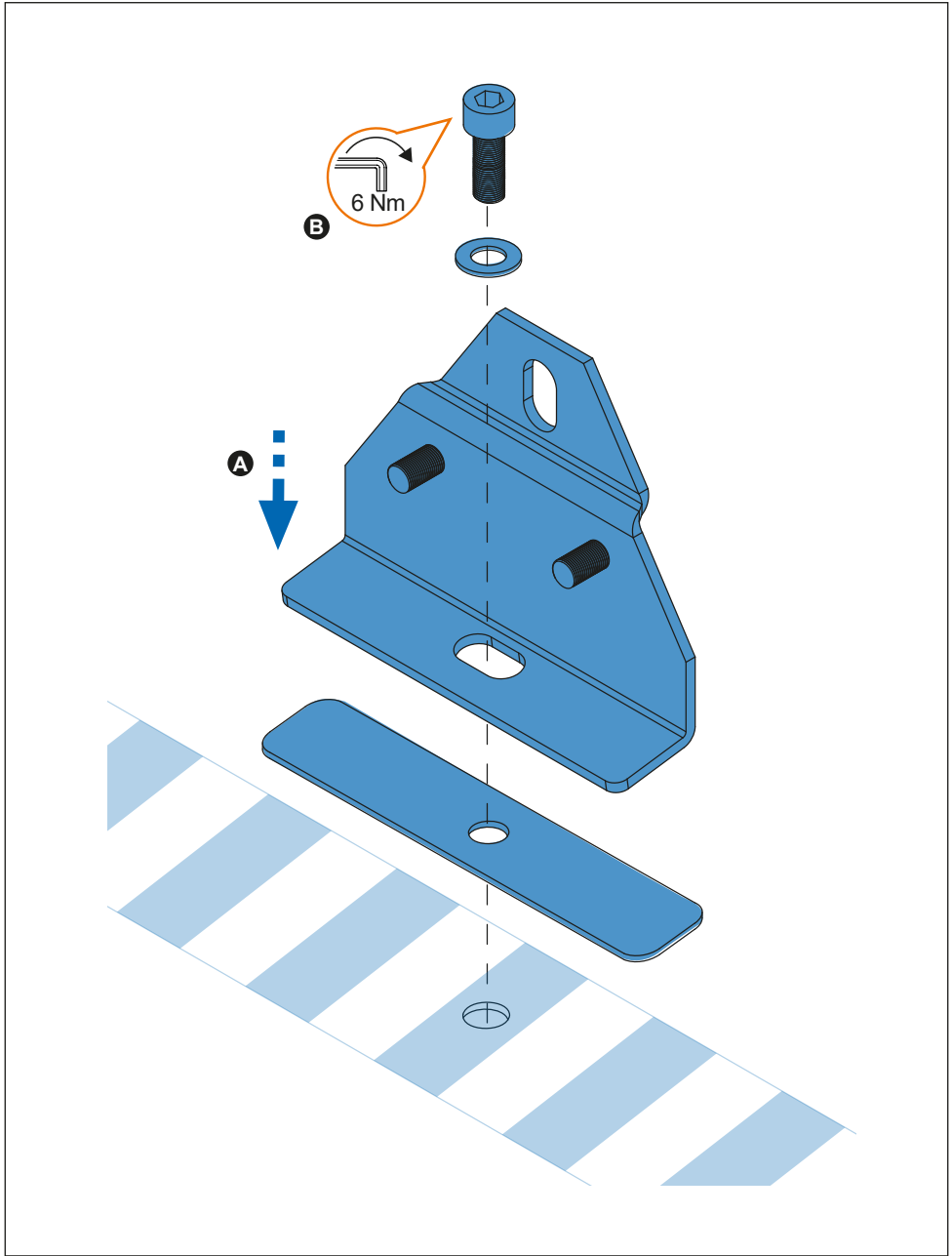

4. 

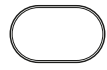

50x30 mm

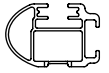

52x35 mm
Aluminium



5. 

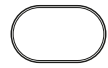

50x30 mm



52x35 mm
Aluminium

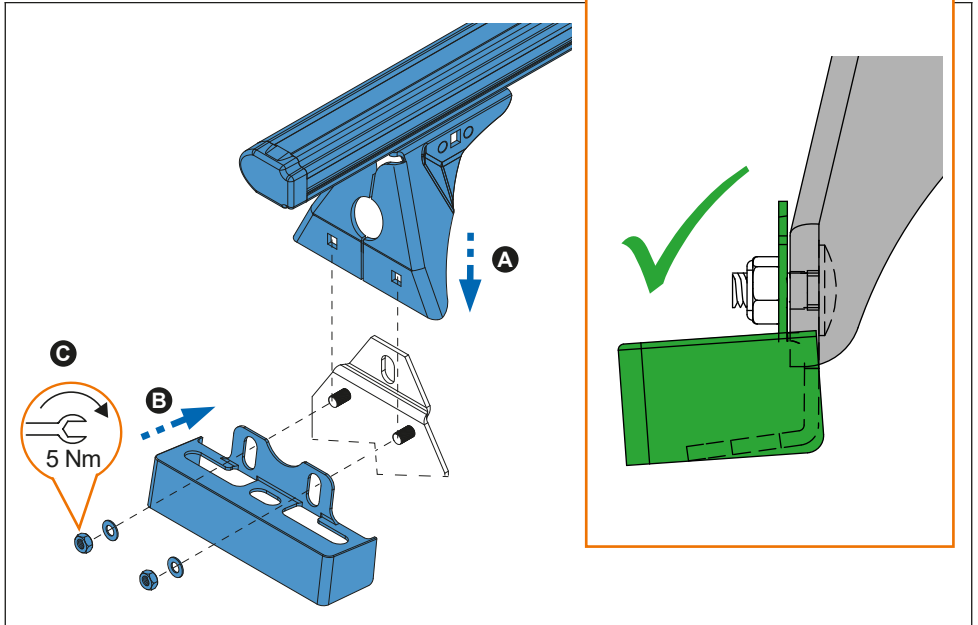
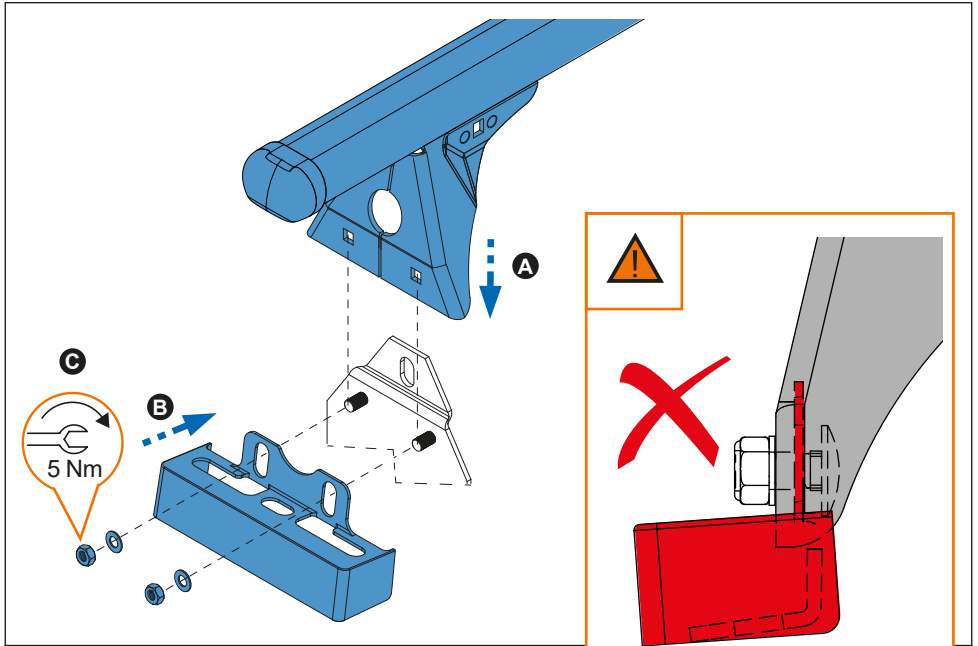

6. 

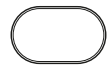

50x30 mm



52x35 mm
Aluminium

