



ES	<b>Instrucción de montaje</b> ¡Leer primero!	Kit fijación
EN	<b>Assembly instructions</b> Read first!	Fixation Kit
FR	<b>Instruction de montage</b> Lire en premier!	Kit fixation
DE	<b>Montageanleitung</b> Zuerst lesen!	Stützfuß-Kit
PT	<b>Instruções de montagem</b> Ler primeiro!	Kit fixação
IT	<b>Istruzioni di montaggio</b> Leggere per primo!	Kit di fissaggio
NL	<b>Montagehandleiding</b> Eerst lezen!	Bevestigingsset
PL	<b>Instrukcja montażu</b> Najpierw przeczytaj!	Element mocujący
CZ	<b>Montážní návod</b> Čtěte pozorně!	Fixační kit
HU	<b>Szerelési Utasítás</b> Először olvasd el!	Rögzítő készlet
HR	<b>Detaljne upute</b> Prvo procitati!	Kit za montažu
RO	<b>Instructiuni de montaj</b> Intai cititi!	Kit de fixare
RU	<b>Инструкции по монтажу</b> Сначала прочитайте!	Крепежный комплект
GR	<b>Διαβάστε προσεκτικά τις</b> Οδηγίες Συναρμολόγησης!	Κιβώτιο (Kit) Επισκευής
TR	<b>Öncelikle montaj:</b> Talimatlarını okuyunuz!	Montaj kiti
SI	<b>Navodila za sestavljanje</b> Preberite!	Kit za pričvrstitev

# 935-795

Lv7 2022-r4

Modelo-model:

## Kit CRUZ Optiplus

Lote-Lot-Lot-Lot:

**02-22**

Peso-Weight-Poids-Gewicht:

**0,83 kg / 1,83 lbs**



Kit tipo (Certificación)  
Kit type (Certification)  
Kit type (Certificat)  
Kit Typ (Zertifizierung)

**A**

CEE - EEC type approval:







26 R- 04 3015

CRUZBER SAU  
ES-A14018311  
P.I. Las Salinas II  
14960 - Rute - Spain  
cruz-products.com



1.

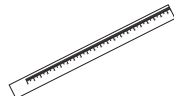
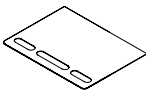

x1		x1	 (018-041)	x1	 (810-045)	x4	 1x (2563) 1x (2564) 1x (2565) 1x (2566)
x4	 2x (012-070) 2x (012-090)	x1	 (001-820)	x4	 (018-098)		



**Importante!**  
**Important!**  
**Important!**  
**Wichtig!**

ES ¡Este Kit de fijación tiene que usarse con sistemas porta-cargas CRUZ!

EN This fixation Kit must be used with CRUZ roof rack systems!

FR Cet Kit de fixation devra être utilisé avec les systèmes porte-charge CRUZ!

DE Dieser Stützfuß-Kit muß mit CRUZ Dachträgersystemen benutzt werden!

PT Este Kit de fixação deve ser utilizado com os sistemas porta cargas CRUZ!

IT Questo kit di fissaggio deve essere usato con i portapacchi CRUZ

NL Deze bevestigingsset moet worden gebruikt in combinatie met CRUZ dakdrager systeem!

PL Niniejszy element mocujący musi być używany z systemami bagażników dachowych firmy CRUZ!

CZ Tento fixační kit musí být používán s nosným systémem CRUZ!

HU Ez a rögzítő készlet csak a CRUZ rendszerekkel használható!

HR Kit za montažu mora biti korišten uz CRUZ sistem krovnog nosača!

RO Acest Kit de fixare, trebuie utilizat cu sisteme CRUZ!

RU Крепежный комплект должен быть использован с багажной системой на крышу марки CRUZ!

GR Το αξεσουάρ αυτό θα πρέπει να χρησιμοποιείται αποκλειστικά στα συστήματα μπαρών της CRUZ!

TR Bu aksesuar mutlaka CRUZ taşıma sistemleriyle kullanılmalıdır!

SI Kit za pričvrstitev naj se uporablja le z izdelki iz asortimana strešnih košar CRUZ!

## 2.

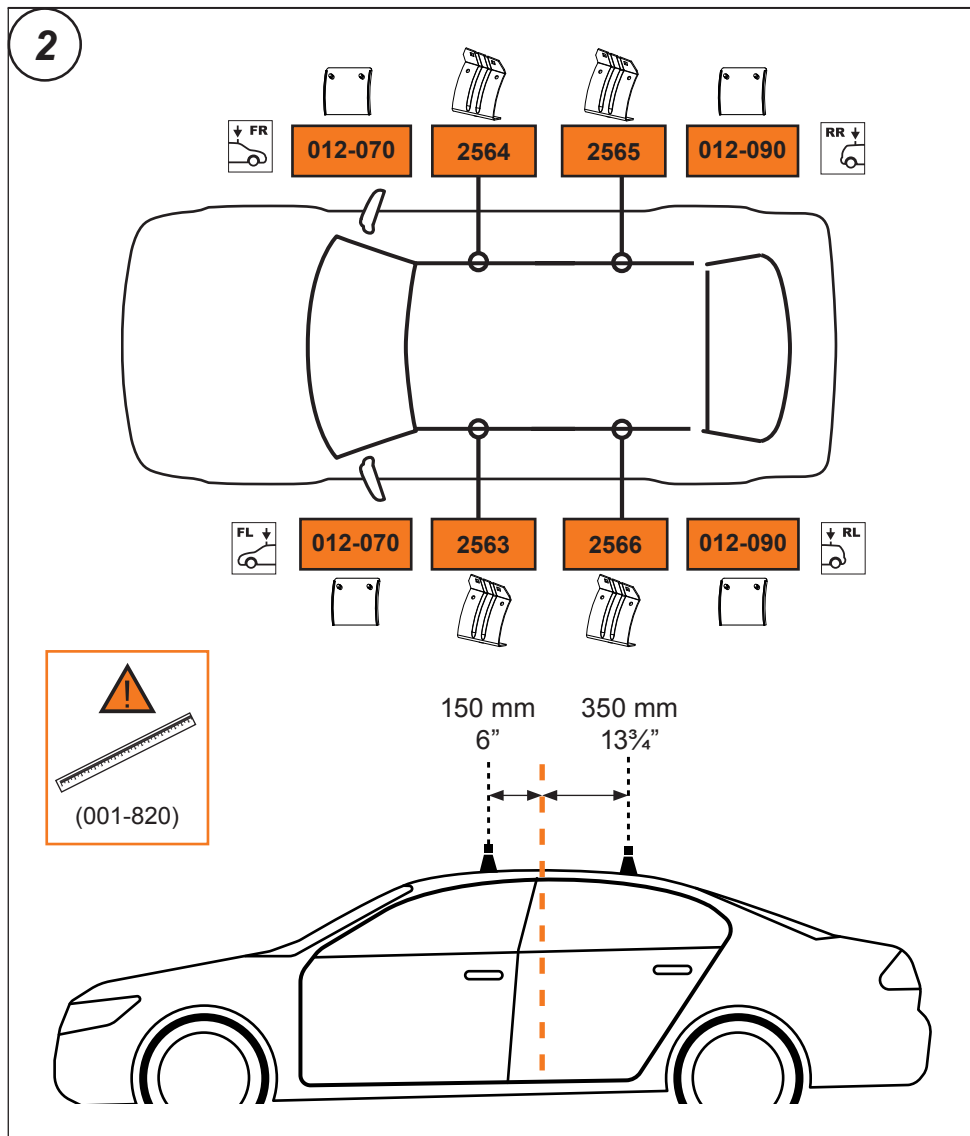

3. 



4. 



5. 



# 6.

