



| | | |
|----|---|-------------------------|
| ES | Instrucción de montaje ¡Leer primero! | Kit fijación |
| EN | Assembly instructions Read first! | Fixation Kit |
| FR | Instruction de montage Lire en premier! | Kit fixation |
| DE | Montageanleitung Zuerst lesen! | Stützfuß-Kit |
| PT | Instruções de montagem Ler primeiro! | Kit fixação |
| IT | Istruzioni di montaggio Leggere per primo! | Kit di fissaggio |
| NL | Montagehandleiding Eerst lezen! | Bevestigingsset |
| PL | Instrukcja montażu Najpierw przeczytaj! | Element mocujący |
| CZ | Montážní návod Čtěte pozorně! | Fixační kit |
| HU | Szerelési Utasítás Először olvassd el! | Rögzítő készlet |
| HR | Detaljne upute Prvo procitati! | Kit za montažu |
| RO | Instructiuni de montaj Intai cititi! | Kit de fixare |
| RU | Инструкции по монтажу Сначала прочитайте! | Крепежный комплект |
| GR | Διαβάστε προσεκτικά τις Οδηγίες Συναρμολόγησης! | Κιβώτιο (Kit) Επισκευής |
| TR | Öncelikle montaj: Talimatlarını okuyunuz! | Montaj kiti |
| SI | Navodila za sestavljanje Preberite! | Kit za pričvrstitev |

936-608

Lv7 2022-r2

Modelo-model:

CRUZ Optiplus Rail FIX

Lote-Lot-Lot-Lot:

02-22

Peso-Weight-Poids-Gewicht:

1,12 kg / 2,47 lbs



Kit tipo (Certificación)
Kit type (Certification)
Kit type (Certificat)
Kit Typ (Zertifizierung)

E

CEE - EEC type approval:



26 R- 04 3015

CRUZBER SAU
ES-A14018311
P.I. Las Salinas II
14960 - Rute - Spain
cruz-products.com



1.



x1



x1



(018-041)

x1



(810-052)

x1



(001-820)

x4



1x (3385)
1x (3387)
1x (3389)
1x (3391)

x4



1x (3386)
1x (3388)
1x (3390)
1x (3392)

x4



(012-090)

x4



(018-099)

x4



(012-226)



Importante!
Important!
Important!
Wichtig!

IT Questo kit di fissaggio deve essere usato con i portapacchi CRUZ

RO Acest Kit de fixare, trebuie utilizat cu sisteme CRUZ!

ES ¡Este Kit de fijación tiene que usarse con sistemas portacargas CRUZ!

NL Deze bevestigingsset moet worden gebruikt in combinatie met CRUZ dakdrager systeem!

RU Крепежный комплект должен быть использован с багажной системой на крышу марки CRUZ!

EN This fixation Kit must be used with CRUZ roof rack systems!

PL Niniejszy element mocujący musi być używany z systemami bagażników dachowych firmy CRUZ!

GR Το αξεσουάρ αυτό θα πρέπει να χρησιμοποιείται αποκλειστικά στα συστήματα μπαρών της CRUZ!

FR Cet Kit de fixation devra être utilisé avec les systèmes porte-charge CRUZ!

CZ Tento fixační kit musí být používán s nosným systémem CRUZ!

TR Bu aksesuar mutlaka CRUZ taşıma sistemleriyle kullanılmalıdır!

DE Dieser Stützfuß-Kit muß mit CRUZ Dachträgersystemen benutzt werden!

HU Ez a rögzítő készlet csak a CRUZ rendszerekkel használható!

SI Kit za pričvrstitev naj se uporablja le z izdelki iz asortimana strešnih košar CRUZ!

PT Este Kit de fixação deve ser utilizado com os sistemas porta cargas CRUZ!

HR Kit za montažu mora biti korišten uz CRUZ sistem krovnog nosača!

2. 

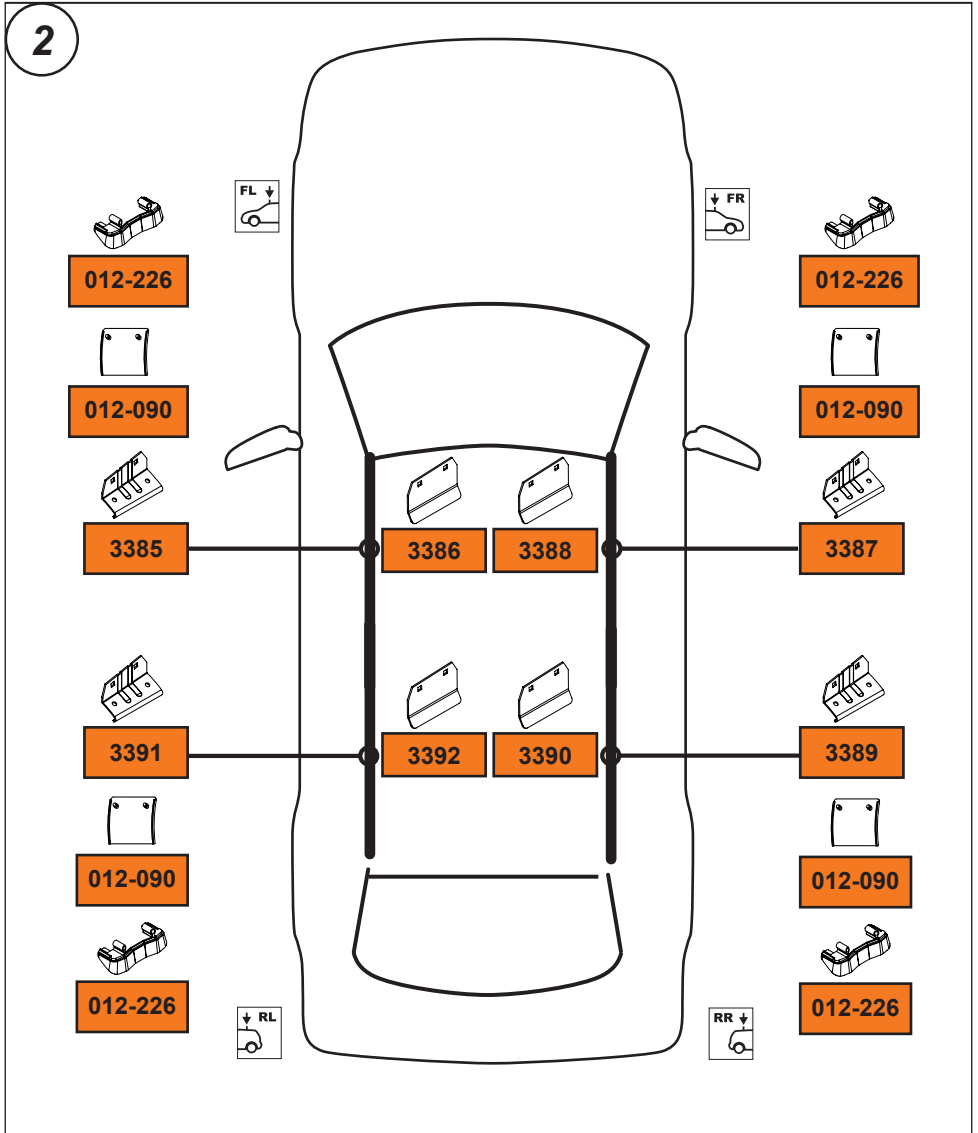

3. 

Cruz Airo Fuse



4,5,6,7,8,9,15

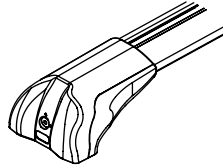

Cruz Airo FIX / Cruz Oplus S-FIX



4,10,11,12,13,14,15

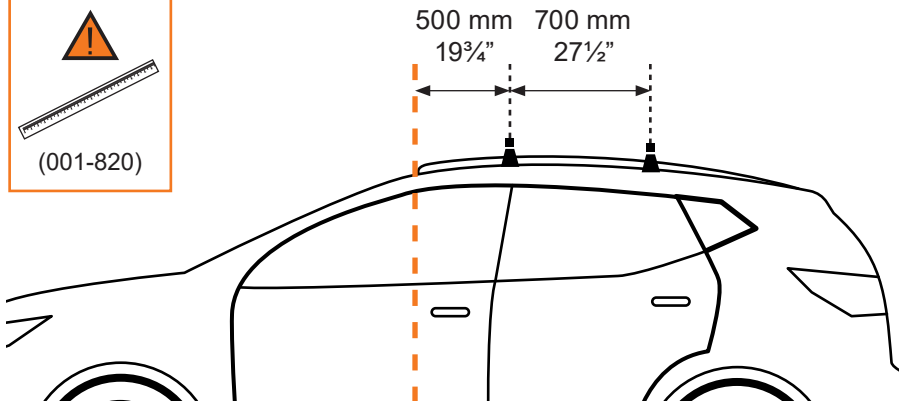

4. 



5. 

Cruz Airo Fuse

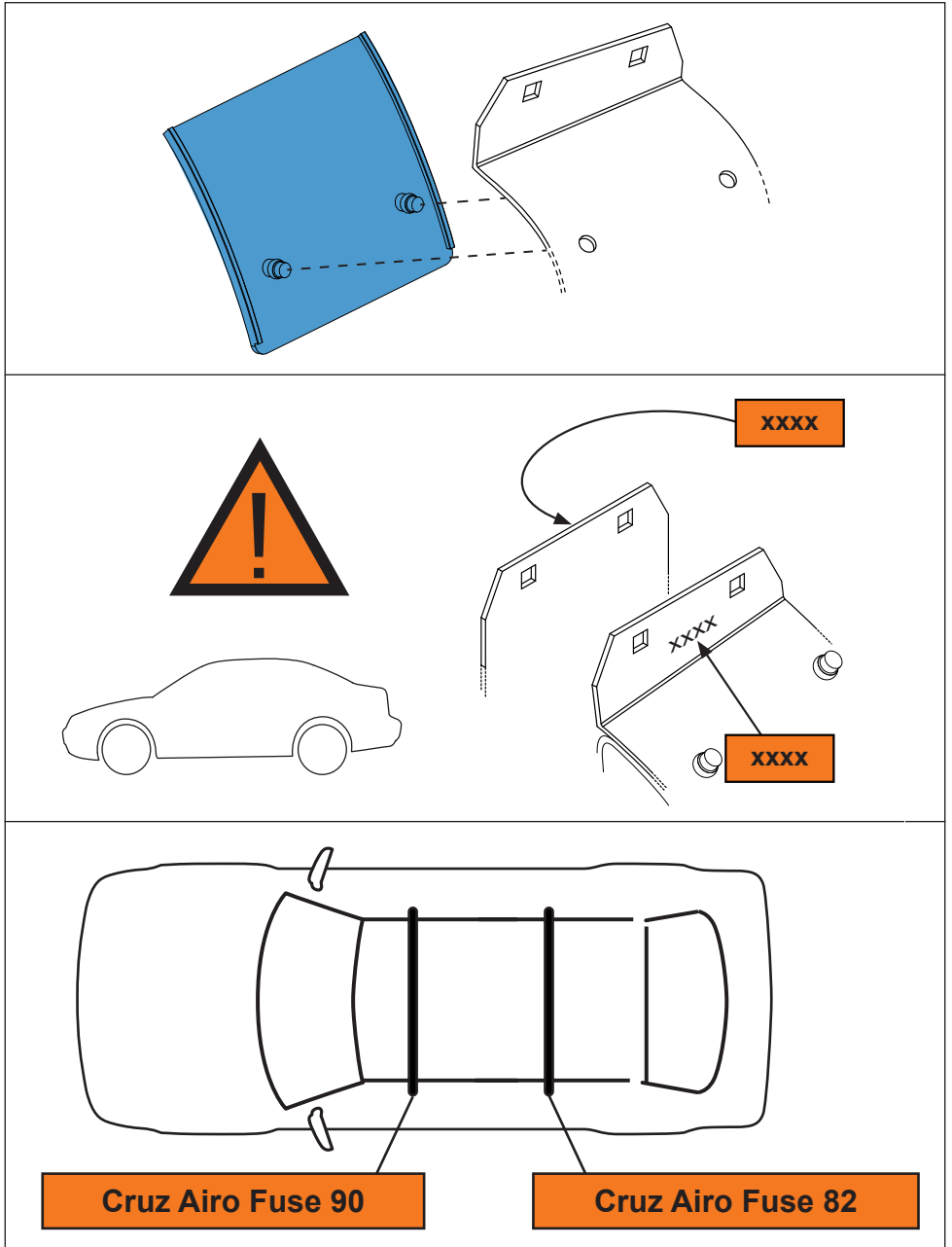

6. 

Cruz Airo Fuse



7. 

Cruz Airo Fuse



8. 

Cruz Airo Fuse

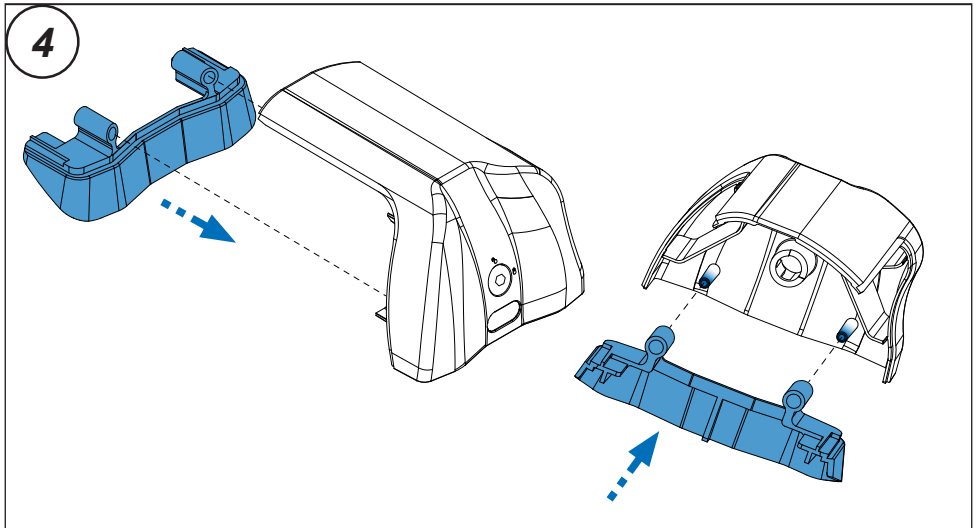
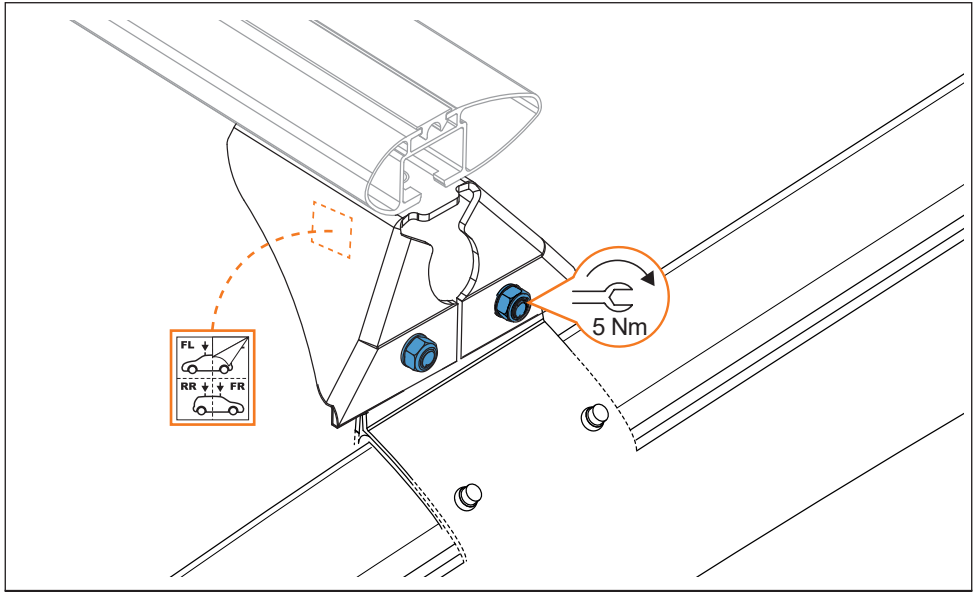

9. 

Cruz Airo Fuse



10.



Cruz Airo FIX / Cruz Oplus S-FIX

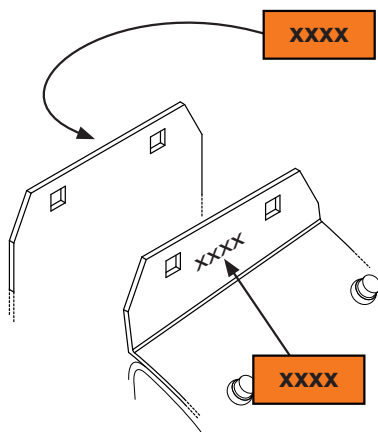
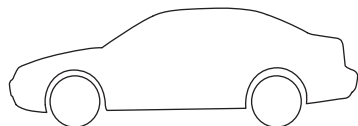
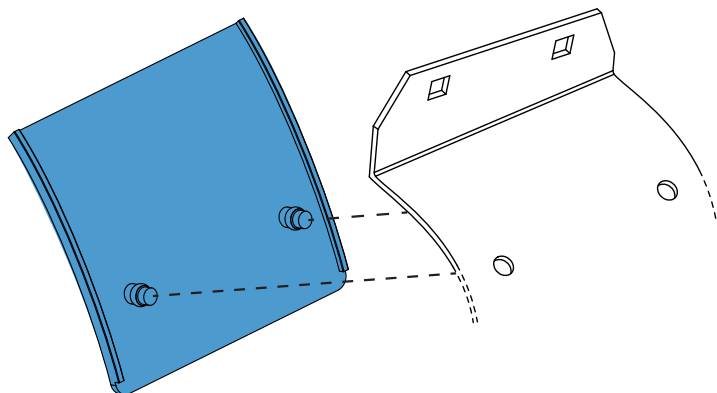

11.



Cruz Airo FIX / Cruz Oplus S-FIX



12.



Cruz Airo FIX / Cruz Oplus S-FIX

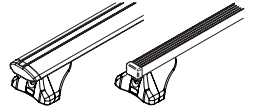

13.



Cruz Airo FIX / Cruz Oplus S-FIX



14.



Cruz Airo FIX / Cruz Oplus S-FIX



15.

